

# AS4028 SERIES

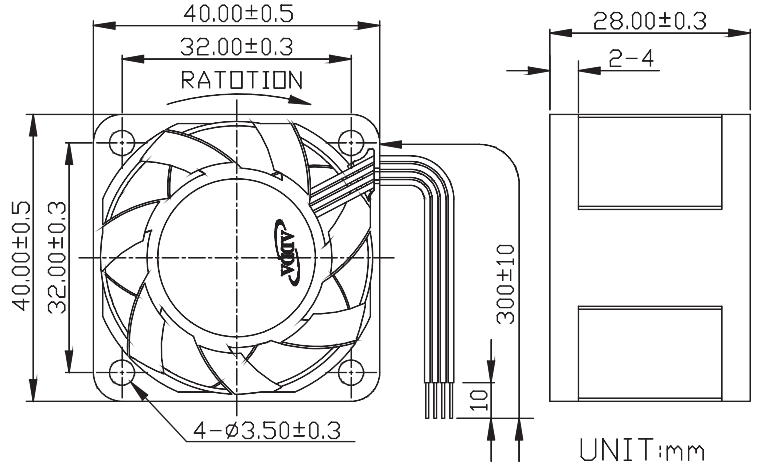

## External Dimensions



Frame:Plastic(UL:94V-0)  
 Impeller:Plastic(UL:94V-0)  
 Lead wire:UL1061AWG26

## Specifications(Nominal)

\*Noise is measured at the distance of one (1) meter from the axis of intake.

Bearing type: ◎=Ball ※=Sleeve ●=Hypro bearing

Frame size (mm)	Model No.	Bearing System Type	Rated Voltage (VDC)	Rated Current (A)	Rated Power (W)	Rated Speed (rpm)	Maximum AirFlow (CMM)	Maximum AirFlow (CFM)	Maximum Pressure (InAq)	Maximum Pressure (mmAq)	*Noise Level (dB/A)	Weight (g)
40x40x28	AS04012HB285BA0(00LAP)	◎	12	0.45	5.40	16500	0.536	18.920	1.819	46.209	53.8	41.0
	AS04012UB285BA0(00LAP)	◎	12	0.52	6.24	18000	0.595	20.998	2.092	53.148	56.7	



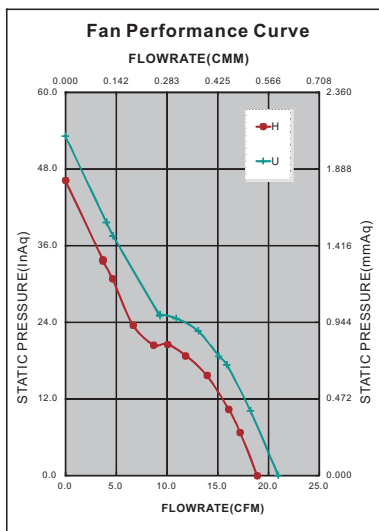

Specifications subject to change without notice.



\*Motor protective circuit and third lead wire functions

0	1	2	3	4	6	7	8	9	A	B
	✓	✓	✓							✓

\*Safety approvals

				
✓	✓		✓	✓